



SPECIFICATIONS

SS-1200NP-G360* CC DRIVER

Model: SS-1200NP-G360*

Power: 1200W

Rev.: V01

Release date: 2026-03-06

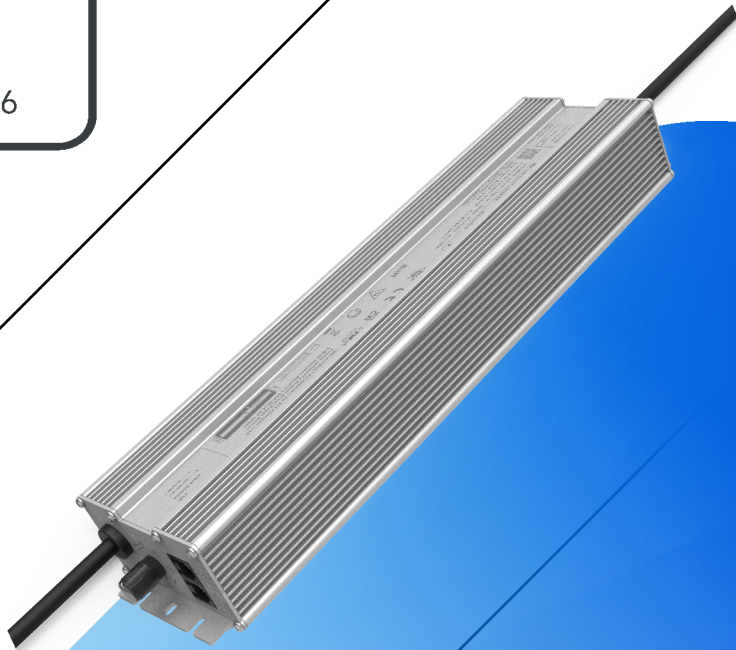

SS-1200NP-G360XX Series LED Driver

Features

- Efficiency up to 97%
- Dimming: 0-10V,PWM,Resistor,Timing
- Dim-to-Off
- Dual-live-wire input off without afterglow
- Surge protection: CM: 6kV, DM: 6kV
- AUX Power: 12V/0.25A
- Constant Lumen, Life Warning
- External NTC to Protect LED Module
- Standby Power<0.5W
- Communication with PC
- Protections: SCP/OTP/UVP/OPP
- Warranty: 5 years

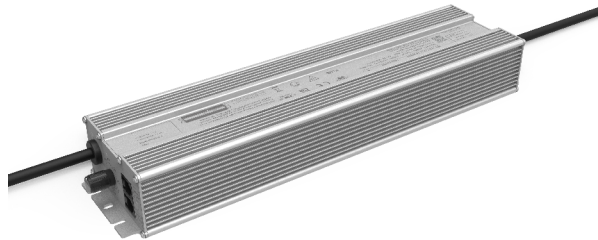

RoHS IP67

Description

SS-1200NP-G360XX is 1200W non-isolated constant current LED Driver with 180-305Vac input and wide O/P voltage range and adjustable O/P current by program. LED luminaire manufactures can easily design luminaires and reduce cost.,It has comprehensive protection, including short circuit protection and over-temperature protection.

Applications:

Horticulture lighting, Stadium lighting, Fish lighting

Model List:

Model	AC Input Range	Max. Pout	Vout Range	Full Power Vo Range	Iout	THD (Typ.)	PF(Typ.)	Eff.(Typ.)	Max.Tc
SS-1200NP-G360BH*	180-305Vac	1200W	210-360V	240-360V	0.7-5.0A	10%	0.95	96%	90°C

Note:

1.Default Tested: at 220Vac, full load, Ta 25°C;

2. The performance of the LED Driver can be guaranteed within the full power Vo range. The voltage lower than full power Vo range, it is need to test the performance with the LED module ;

SS-1200NP-G360XX Series LED Driver

“*” Means Additional Function

“*”	AC INPUT		DC OUTPUT				Dimming		Remark
	Cable	M19-3Pin	Cable	M19-2Pin	M19-3Pin	M19-4Pin	Knob&RJ25	M12-3Pin	
BHB	✓		✓				✓		

Input Characteristics:

Parameter	Min.	Typ.	Max.	Remark
Rated AC Input Range	200Vac		277Vac	<Ta:50°C
AC Input Range	180Vac		305Vac	<180Vac, Automatic Output Power Derating
Input Frequency Range	47Hz	50/60Hz	63Hz	
Max Input Current			7.5A	200Vac, Full load
Max Input Power			1300W	200Vac, Full load
Max Inrush Current(200Vac)			70A	Cold start
Max Inrush Current(277Vac)			70A	Cold start
Standby Power			0.5W	230Vac/50Hz, Dim-off
Power Factor	0.95	0.97		220Vac/50Hz, Full load
	0.90			200-277Vac, 70-100% load
THD		10%		220Vac/50Hz, Full load
			20%	200-277Vac, 70-100% load

SS-1200NP-G360XX Series LED Driver

O/P Characteristics:

Parameter	Min.	Typ.	Max.	Remark
O/P Voltage Range	210V		360V	Power derated @210-240V
Rated O/P Voltage	240V		360V	Po=Vo*Io=1200W, Full load
Rated O/P Current	3.33A		5.0A	5.0A for 240V,3.33A for 360V
Adj. O/P Current (AOC)Range	0.7A		5.0A	Adjustable by program
No Load Voltage			390V	
Efficiency @220Vac	94.0%	96.0%		O/P 360V/3.33A
Efficiency @277Vac	95.0%	97.0%		O/P 360V/3.33A
O/P Current Tolerance	-5%		+5%	
O/P Current Ripple(PK-AV)		5%	10%	Full load
Start-up Current Overshoot			10%	Full load
Start-up Time			0.5S	200-277Vac,Full load,
Line Regulation	-2%		+2%	Full load
Load Regulation	-2%		+2%	-40°C, ±5%
Temperature Coefficient	-0.03%/°C		+0.03%/°C	Tc:0°C~90°C
OTP	90°C	95°C	110°C	Drop current when OTP, and it can be automatically restored after the abnormality is removed.
Short Circuit Protection				Driver will not be damaged, Constant current mode

SS-1200NP-G360XX Series LED Driver

Other Characteristics:

Parameter		Min.	Typ.	Max.	Remark
AUX Power	O/P Voltage	10.8V	12V	13.8V	
	O/P Current			250mA	
0-10V Dimming (Optional)	Dim Vmax	0V		12V	Dimming prohibits reverse connection. DIM+ source current 110uA .
	Dim Range	10%loset		100%loset	
	Rec.Dim Range	0V		10V	
PWM Dimming (Optional)	PWM High	9.8V		10.2V	
	PWM Low	0V		0.3V	DIM+ source current 110uA .
	Frequency	1KHz		2KHz	Dimming prohibits reverse connection.
Resistor Dimming (Optional)	PWM Duty	0%		100%	
	Resistance	0Kohm		100Kohm	
0-10V Dim to Off	Dim Range	10%loset		100%loset	DIM+ source current 110uA .
	Dim off	7%	8%	9%	By DC voltage, PWM, resistance dimming ratio
	Dim on	8%	9%	10%	By DC voltage, PWM, resistance dimming ratio
NTC Founction(Optional)	By programming				External resistance value 10K Ω , B value 3950 or 3435 NTC thermistor, set parameters through corresponding programs
Timing Curve(Optional)	By programming				Set by program
Constant Lumen(Optional)	By programming				Set by program
Life Warning(Optional)	By programming				Set by program
Life Time(Tc \leq 75 $^{\circ}$ C)	50,000 hours				80% Load, 230Vac
MTBF	198,800 hours				220Vac, Full load, Ta=25 $^{\circ}$ C (MIL-HDBK-217F)
Tc	90 $^{\circ}$ C				
Warranty	5 years				Tc:75 $^{\circ}$ C
Net Weight	2.95Kg				
Dimension	365mm*89.5mm*49.0mm				L x W x H

NOTE: 1.All the parameters above are tested Ta 25 $^{\circ}$ C and LED load, unless specified.

2. When using resistor dimming (parallel connection of dimming wires), if the number of parallels is: N, the dimming resistor should be realized 0-100% dimming range, resistance value: 91K Ω /N.

SS-1200NP-G360XX Series LED Driver

Environmental Requirements

Parameter	Min.	Typ.	Max.	Remark
Operating Temperature(Tcase)	-40°C	25°C	+90°C	
Storage Temperature	-40°C	25°C	+90°C	
Operation Humidity	10%RH		90%RH	
Storage Humidity	5%RH		95%RH	
Altitude	-65m		4000m	

Safety and EMI/EMS Standards

Certification	Standard	Status	Remark
UL	UL8750	✓	
CUL	CAN/CSA C22.2 No.250.13	✓	
ENEC	EN 61347-1 EN 61347-2-13 EN IEC 62384	✓	
RCM	AS/NZS61347.2.13		
CCC	GB/T 19510.1 GB/T 19510.213		
CE	EN 61347-1 EN 61347-2-13 EN 62493	✓	
	EN 301 489-1 EN 301 489-3 EN 300 330 EN 62479/EN 50663/EN 50665/EN 50364		For NFC wireless products

SS-1200NP-G360XX Series LED Driver

Safety and EMI/EMS Standards

EMI/EMS	Standard	Status	Remark
Conduction Emission	EN IEC 55015	✓	230Vac
	GB/T 17743		
	FCC Part 15 Subpart B;ANSI C63.4		
Radiation Emission	EN IEC 55015	✓	230Vac
	GB/T 17743		
	FCC Part 15 Subpart B;ANSI C63.4		
Harmonic Current Emissions	EN IEC 61000-3-2	✓	ClassC
	GB 17625.1		ClassC
Surge	IEC/EN61000-4-5	✓	DM: 6kV,CM: 6kV,Criterion B
	ANSI/C82.77-5		
Ring Wave	IEC/EN 61000-4-12	✓	DM: 6kV,CM: 6kV,Criterion B
	ANSI/C82.77-5		

SS-1200NP-G360XX Series LED Driver

Safety Test Items:

Safety Test Items	Technical Indicators		Remark
Insulation Requirements	UL Insulation Requirements	ENEC Insulation Requirements	
Input-Case	2U+1000	2U+1000	Basic insulation
Input-Dim	2U+1000	4U+2000	Reinforced insulation
Dim-Case	500Vac	500Vac	Basic insulation
Insulation Resistance	$\geq 10M\Omega$		Input-DIM, Test voltage:500Vdc
Ground Resistance	$\leq 0.1\Omega$		25A/1min
Leakage Current	$\leq 0.75mA$		277Vac

NOTE:

1. SOSEN warrants the LED Driver itself complies with EMC standard. However, LED Driver's EMC should be re-checked when integrated into lighting systems due to unexpected interference as component.
2. Please short (ACL and ACN), (V+ and V-), (Dim+ and Dim - and Vaux+) when Hi-pot test (Turn off ARC) .
3. When applying withstand voltage to ground, the input and outputlines need to be short-circuited together.

Performance Curves:

Input Inrush Current

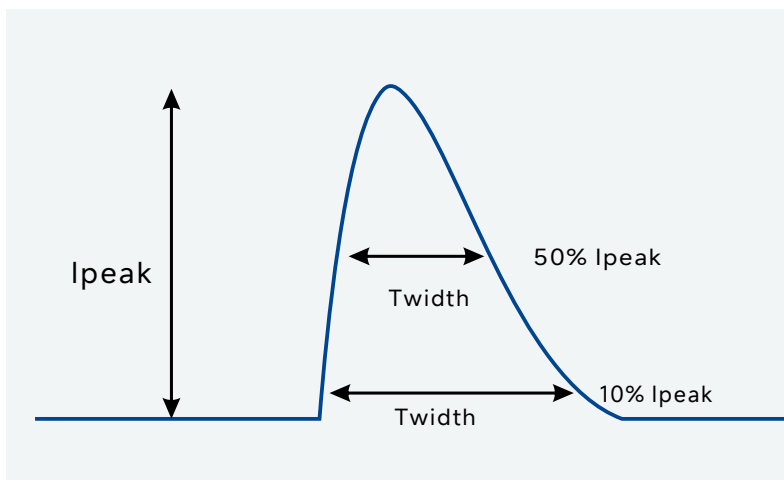

Vin	Ipeak	T(@10% of Ipeak)	T(@50% of Ipeak)
200Vac	70A	10.3ms	3.7ms
277Vac	70A	11.4ms	3.5ms

SS-1200NP-G360XX Series LED Driver

Performance Curves:

Efficiency Vs. O/P Voltage ($V_{in}=200V_{ac}$)

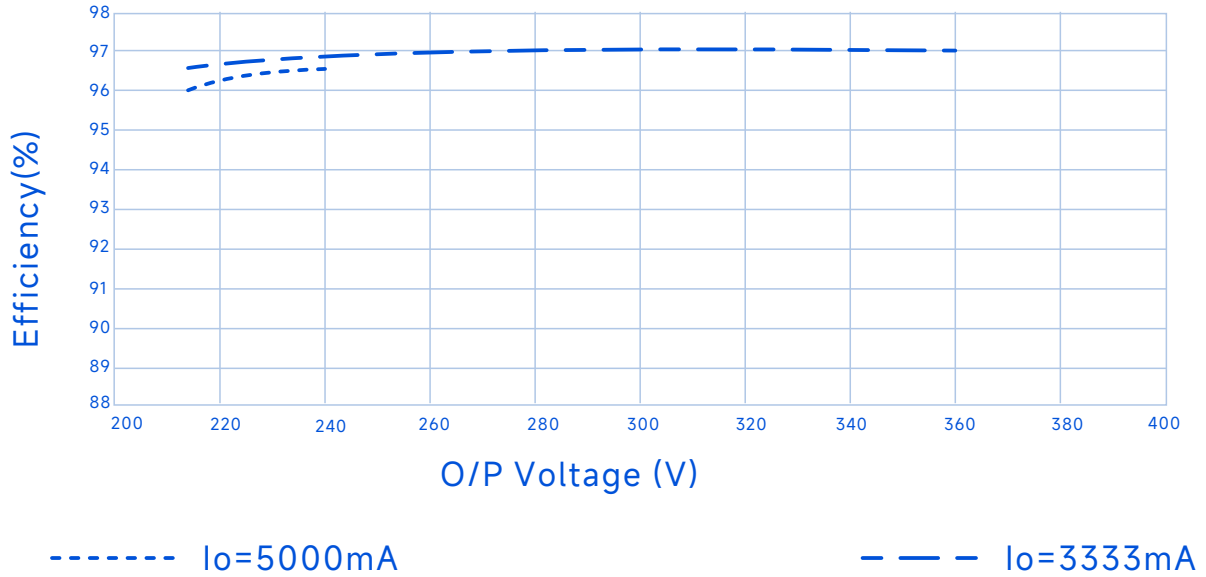

Efficiency Vs. O/P Voltage ($V_{in}=277V_{ac}$)

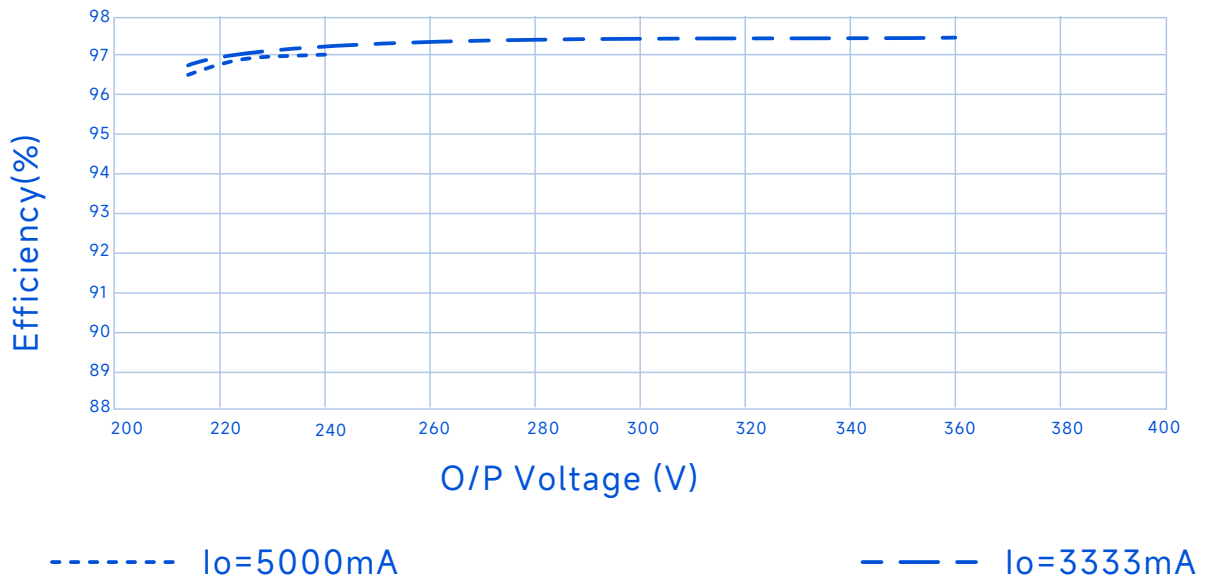

SS-1200NP-G360XX Series LED Driver

Performance Curves:

Power Factor Vs. O/P Power

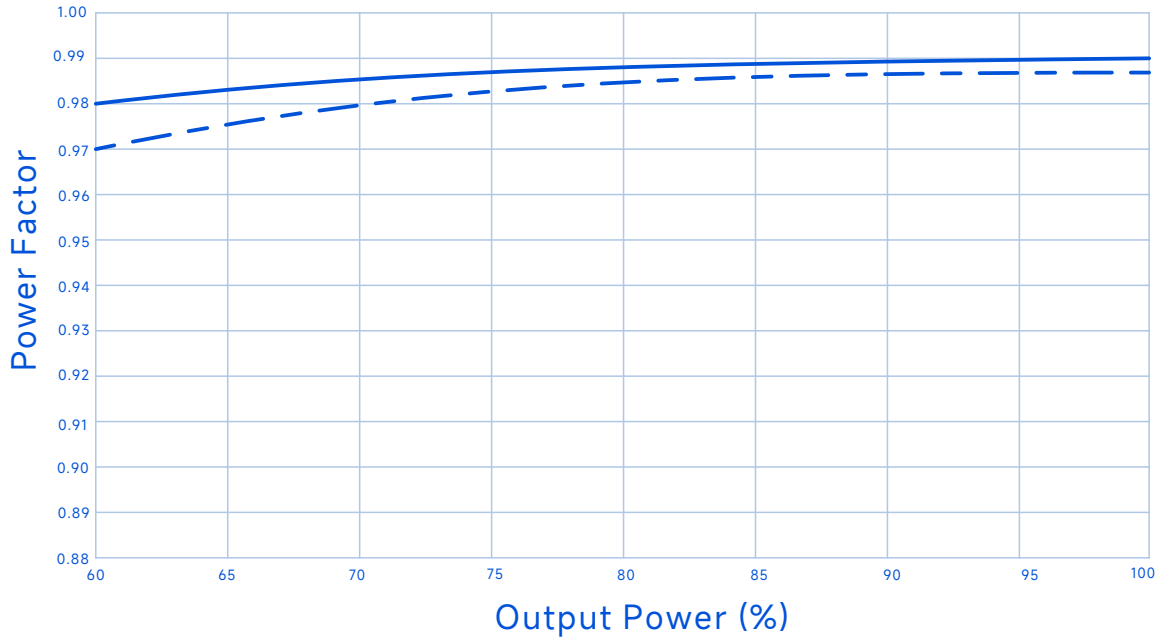

— Vin=200Vac - - - Vin=277Vac

THD Vs. O/P Power

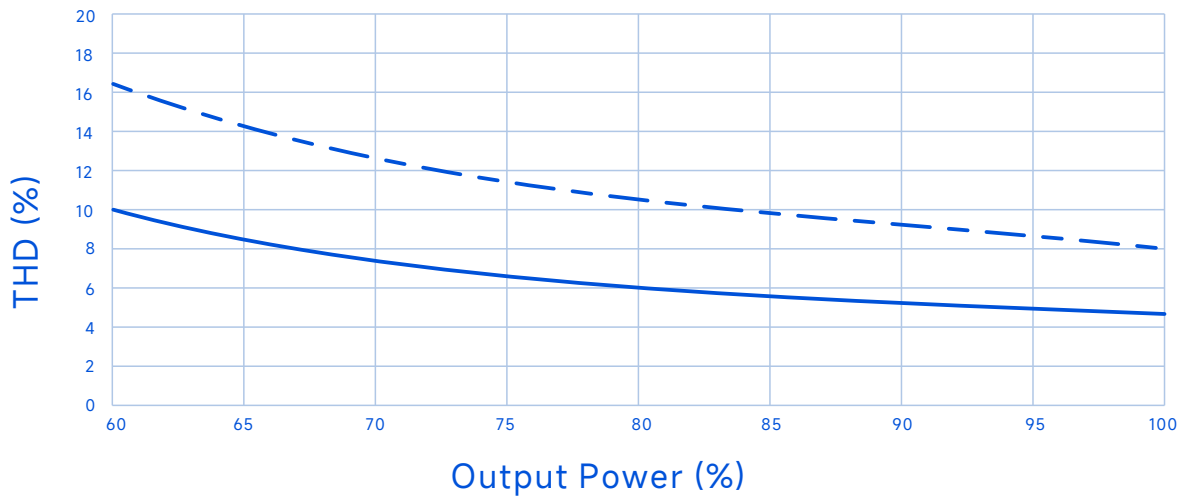

— Vin=200Vac - - - Vin=277Vac

SS-1200NP-G360XX Series LED Driver

Performance Curves:

O/P Power Vs. Input Voltage

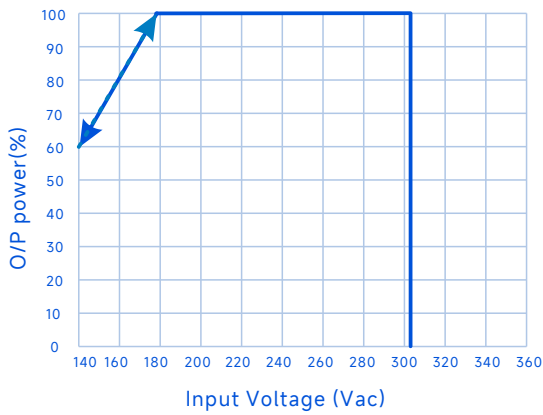

O/P Power Vs. Dimming

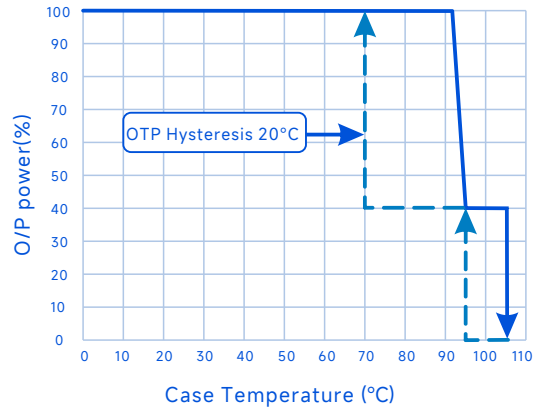

O/P Power Vs. Dimming

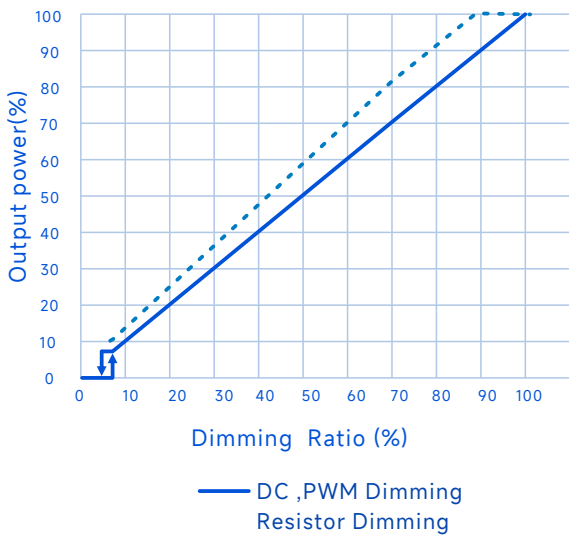

Life Time Vs. Case Temperature

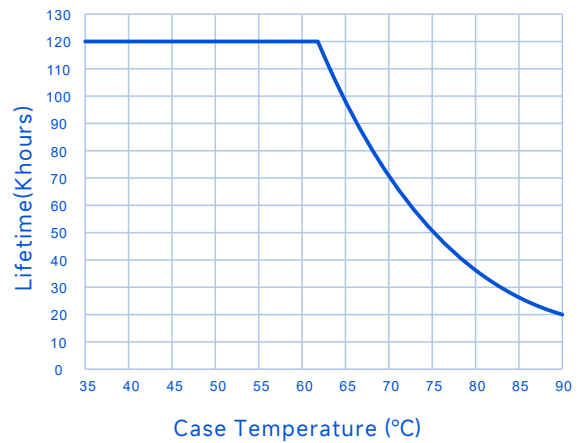

Programming connection diagram

Legacy Timer: Driver's O/P follows the pre-programmed timing curve after turn-on.
Auto-Adjust by Percentage: Driver's O/P will be adjusted by automatically changed dimming curve by the period percentage based on the latest 5 dimming curve.
Auto-Adjust by Mid-point: Driver's O/P will be adjusted by automatically changed dimming curve by mid-point based on the latest 5 dimming curve.

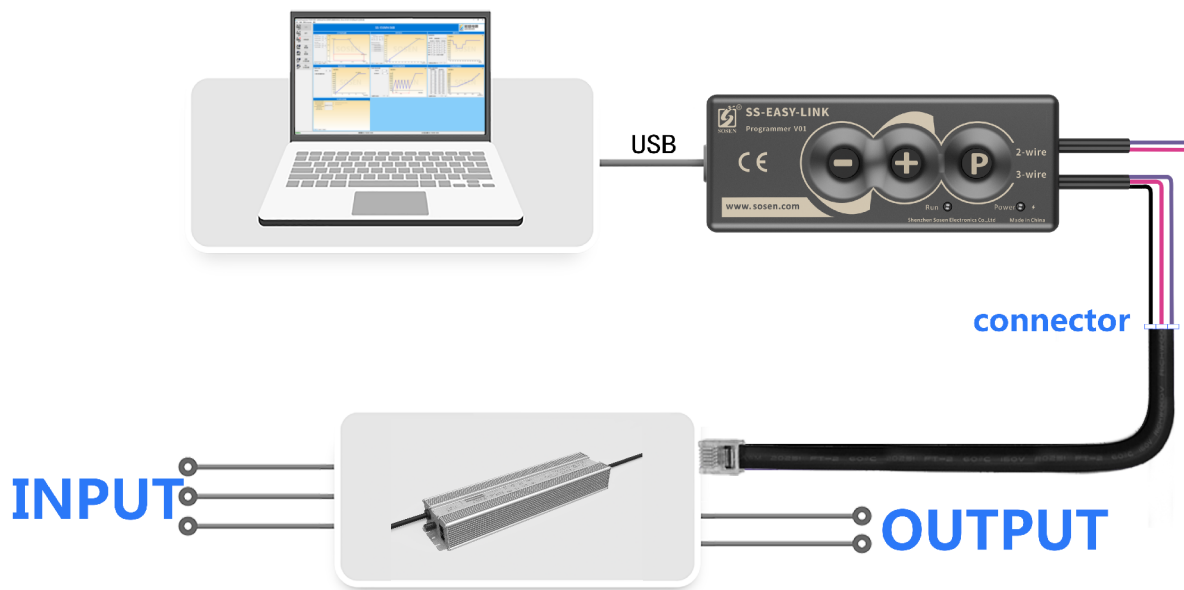

Note:

1. During the programming process, all programming functions can be realized without powering on the driver.
2. All programming functions can be realized without powering off the drive that is currently in use.
3. It can be disconnected from the PC and offline programming can be implemented.

Constant Lumen Output

Constant Lumen Output are design to maintain fixture's stable output lumen by increasing driver's output current within driver's life span to counteract LED lumen degradation.

SS-1200NP-G360XX Series LED Driver

Parameter			Remark
Default setting	Positive logic dimming (0-10V)	Dimming voltage default 10V (source current)	
Dimming optional function	Positive logic dimming (0-10V)	Dimming voltage default 0V (sink current) Resistance dimming not available	When the dimming wire is not connected, the LED driver output is the minimum (to be noted in the order)
			For parallel dimming applications with multiple LED drivers, it is recommended to use the sink current mode (to be noted in the order)

Note:

Select "Dimming voltage defaults to 10V (source current)" / "Dimming voltage defaults to 0V (sink current)", which needs to be set according to the dimmer used by the end user.

Settings Interface

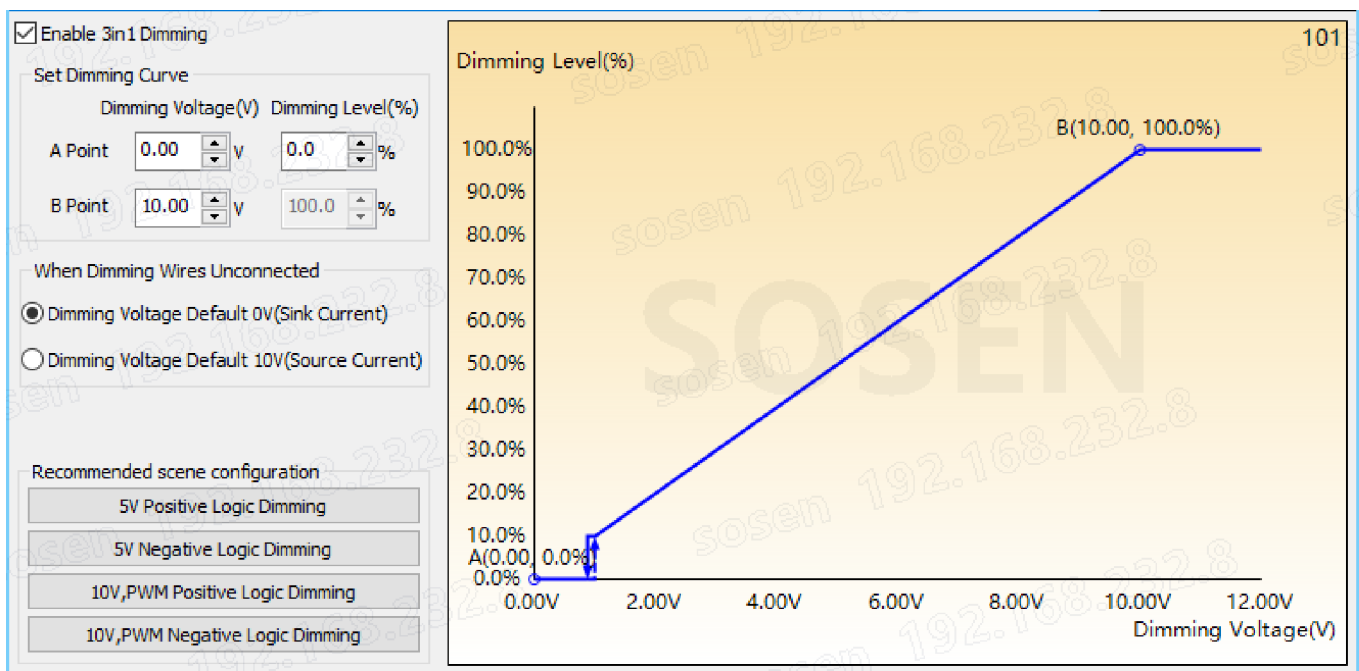

SS-1200NP-G360XX Series LED Driver

Mechanical Characteristics

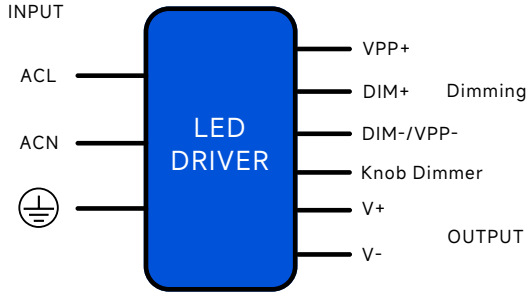

AC Input Cable(Exposed Length 450±10mm):

Global model: SJOW,3*17AWG,O.D: 9.8mm,Brown:L,Blue:N,Yellow/Green: ⊕

DC O/P Cable(Exposed Length 250±10mm):

Global model: SJOW,2*17AWG,O.D: 9.3mm,Brown:V+ Blue:V-

DIM/AUX Power/Programming/NTC Cable:

Knob&RJ25

Name Description	Standard Code	mm(In.)
Overall Length	L1	365(14.37)
Mounting Hole Length	L2	349(13.74)
Case Length	L3	339(13.34)
Case Width	W1	89.5(3.52)
Mounting Hole Width	W2	40(1.57)
Case Height	H	49(1.93)
TC Point Position	X	125(4.92)
TC Point Position	Y	18(0.71)

Note

- 1.Please follow the "LED Driver User Manual" obtained from SOSEN's official website for assembly.
- 2.AC Input Cable,DC O/P Cable Peeled length of cable:43±5mm
Tinned length of wire:10±2mm.

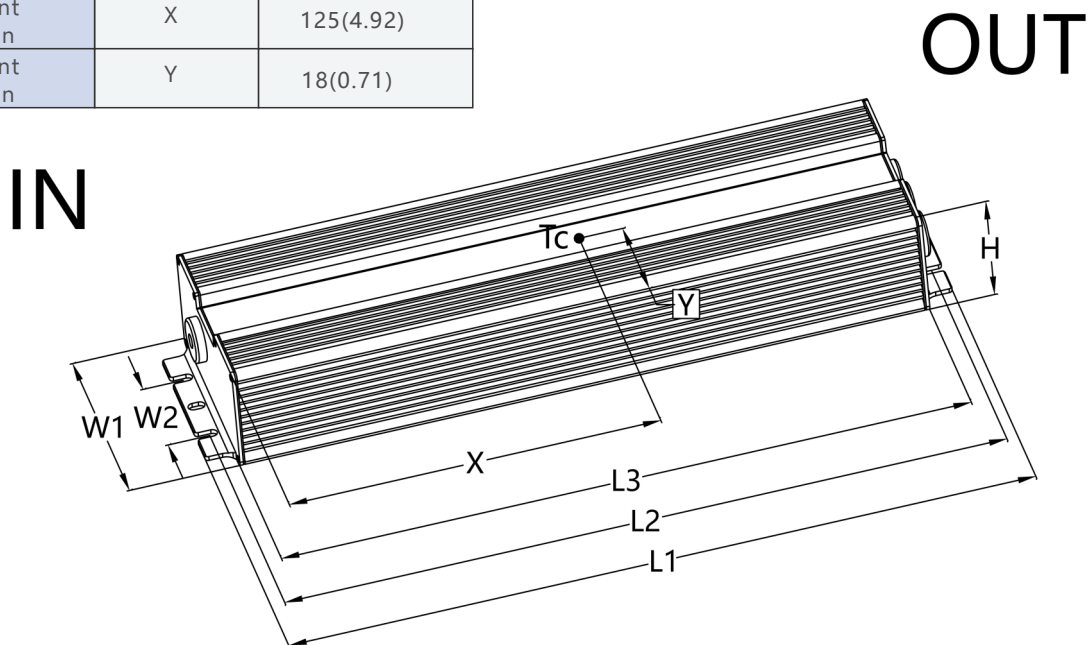

SS-1200NP-G360XX Series LED Driver

Knob/RJ25 terminal definition:



PLUG

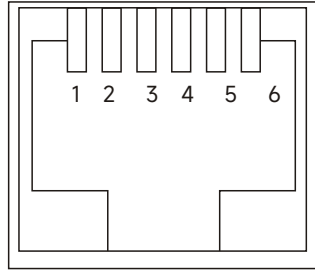

JACK

RJ25 PIN	定义
1&6	VPP+
2&5	DIM+
3&4	DIM-/VPP-

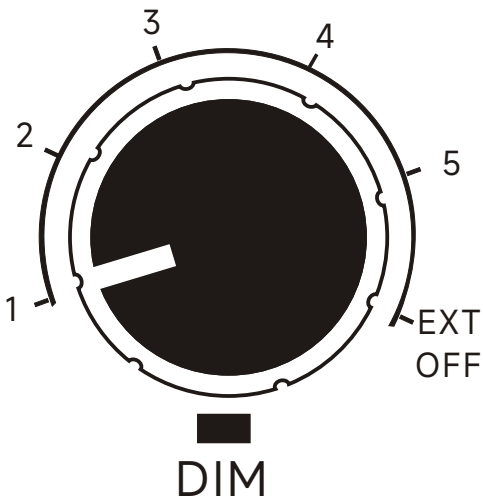

开关	定义
1	40%loset
2	50%loset
3	60%loset
4	80%loset
5	100%loset
EXT/OFF	External Dimming /Dim to off

SS-1200NP-G360XX Series LED Driver



Assembly Tips

1. Dimming or AUX Power tinned connectors should be capped if not used to avoid dimming or AUX Power parts damage from external signals.
2. The trace routing on aluminum substrates is designed in compliance with creepage distance requirements specified by relevant certification regulations.
3. The creepage distance between LED+ and LED- on the aluminum substrate is designed in compliance with the relevant certification regulations.
4. Minimize the copper area on the aluminum PCB to reduce parasitic capacitance and leakage current.
5. It is recommended to design LED beads in parallel first and then in series.
6. The insulation level of LED light panels should meet the reliability design requirements.
7. It's recommended to add resistors or capacitors in parallel with the LED on PCB to reduce the risk of surge when a non isolated LED driver is used for the luminaire
8. For other precautions, please refer to the "LED Driver User Manual".

Warning

Insufficient or compromised insulation voltage resistance in LED light panels may cause breakdown and short circuits to earth, resulting in damage to the luminaire and LED driver, and posing significant safety hazards. It is recommended to install a residual current device (RCD) during application.

Package

- Outside carton dimension: L×W×H =495mm×385mm×162mm;
- 5 PCS/Carton;
- Net weight/Piece: 2.95kg;Gross weight/Carton: 16.12kg;
- Please refer to the product name, model number, manufacturer identification, QC PASS, manufacturing date on the package.

Transportation

Packaging is designed suitable for transportation by trucks, vessels and flights. The products should be avoided direct sunlight and rain, loaded/unloaded with caution.

Storage

The product storage meets the standard of the GB 3873-83.
Products should be rechecked if stored for over 1 year before assembly.

RoHS

Products comply with RoHS Directive (2011/65/EU) and amendment 2015/863/EU.

Revision History

Version	Description of Update	Updated Date	Remark
V00	Original Release	2025/08/15	
V01	Add warning statements	2026/03/06	